



The Reverend Barbara Libby, Interim Pastor
203 389-8946 – barlibby@rhccucc.org
The Reverend Donna K. Manocchio, Senior Pastor Elect
860 529-3013 – associate@rhccucc.org
Meghan Davis Young, Acting Director Christian Education
860 966-2432 – christianed@rhccucc.org
Will Kanute, Director of Music
music@rhccucc.org
860 529-4167 Church – 860 257-9637 Fax
Vol. 24 No. 9 – October 1, 2010



October Newsletter

Editor – Carol Harvey
RHCC e-mail address – office@rhccucc.org
Website: www.rhccucc.org
Office Hours – 8:00 a.m. – 2:00 p.m. M-F
Sunday Worship Services – 10:00 a.m.

Childcare Available/Handicap Accessible



A SERVICE OF INSTALLATION
for The Rev. Donna Kathryn Manocchio
as Senior Pastor of
Rocky Hill Congregational Church,
United Church of Christ
Sunday October 24, 2010
3:00 PM
Reception following the service
Please join the celebration!



A Message From

Pastor Barbara

I write this article in the days following the successful candidating weekend when all of you at RHCC UCC called the Rev. Donna Manocchio to be the next settled Senior Pastor! What great news this is for all of us. Remember – I’m always about working myself out of a job and so I too am always thrilled and pleased to celebrate with you the call of a new Pastor. I am both excited for all of you and proud that the search process was a careful process of discernment by all parties concerned and it is a joy to know that Pastor Donna was called by unanimous vote of the congregation on Sunday, September 12, 2010.

Our Interim time together is already beginning to come to a close. Sunday, October 10th will be my last day among you as Interim Senior Pastor. We will share in a liturgical closure at the end of worship that day that will bring closure to my work among you and the pastoral role commitment to all of you that I made upon my arrival.

Pastor Donna will officially assume the role of Senior Pastor upon my departure that Sunday, October 10th. In the meantime we will be working together to achieve a smooth transition and a careful transfer of leadership. Pastor Donna will move out of her “old” office and into the office that I have used during my 18 months with you. At that time she will leave behind some of the tasks and responsibilities of her Associate’s role and assume the tasks and responsibilities of her new Senior Pastor role. This will take some getting used to by all parties. A job description for her new role is in the process of being formulated so everyone will be clear about her new role.

Pastor Donna will be officially installed by the Hartford Association on Sunday, October 24 at 3:00 p.m. in the RHCC sanctuary. Prior to the installation service, there will be an installation council where Donna will have an opportunity to speak to Association Representatives and answer any questions they might have. This Installation worship invites the entire RHCC congregation, the clergy from all the churches of the Association, and the lay delegates from all Hartford Association churches to join in the celebration of Pastor Donna’s new call. I hope you will join in this celebration in the life of the church! A reception will follow. Watch for more details.

As per their constitutional responsibility, plans by the Diaconate are already under way to find a person to become Acting Associate Pastor here at RHCC

UCC and to take on those responsibilities that Pastor Donna will not continue with as she moves into the Senior Pastor role. The Church Council has agreed with us that an Acting Associate needs to be in place at least through this program year (September 2010 – June 2011). This will allow for some time for Donna and the church to settle into a new relationship, and to attend to several other transitions of staff yet to happen between now and June. Dick Webster, Sexton, is retiring in May and Will Kanute, Director of Music, is departing in June. Stay tuned as details about this Acting position become clear.

This is an exciting time of transition in the life of RHCC UCC. Please know that you will all continue in my prayers even as we part to go our separate ways. My time among you has been valuable for me and I hope it has been the same for you.

Blessings to all,

Barbara



Sunday, October 17
Fiorilli Room, 11:30 AM

The sermon on Sunday, October 17th will focus on worship: why we need to worship and how we participate in worship. Join Pastor Donna for a conversation about the sermon theme. Bring your responses, thoughts, and questions!

A Word of Gratitude

Dear Friends and Members of RHCC, UCC,

Thank you for your affirmation of my call as senior pastor on September 12. I am grateful to God and to all of you for entrusting me with leadership in this congregation. Let us continue to pray for and with each other, that God will deepen our faith and inspire us to discover new ways to live the good news!

In gratitude,

Donna

A Message From the Diaconate

The church constitution charges the Diaconate with 3 areas of concentration. No one aspect is more important than the others, all require continued thought and attention. As this church season begins, our board has an awareness of the need to assess our *membership vitality*.

Rally Sunday marked the beginning of Christian Ed programs and its commitment to youth, the future of our congregation. We are so grateful for that group, for Meghan and for all the teaching volunteers.

Heritage Sunday, the following week, celebrated the many members who have brought us to the place we are; folks who have been members for 50 years or more who have served and worshipped and continue to connect us to our Rocky Hill Congregational roots. The lovely roses were crafted at Julia Pickett's direction. Judy Graham and Gail Tine became quickly proficient.

In the near future we will host a breakfast for folks who have recently joined in our membership to continue a spirit of welcome and solicit their impressions of the spiritual life here at RHCC.

Many of the statements from our Visioning process relate to growing a vital membership and belonging to an active, welcoming family in which we experience God's blessings. To help accomplish these and other goals it is with great excitement I introduce 2 new deacons:

Val Triblets has finished her role as a member of the search committee so her familiarity with our "profile" and our vision will be valuable. Even more helpful, as a mother of younger children, will be her perspective on integrating our younger members into church life. She now lends her voice to our board as well as from the choir loft.

Don Pagnucco is new to our membership but not new to church activities and volunteer roles. He and his wife, Polly, served in many capacities in their previous Methodist community. In the time he has been involved I dare say there have been very few activities to which he has not contributed. His experiences will be valuable, and his enthusiasm inspiring.

As we prepare to welcome and install Donna as our senior pastor, say "thank you & God be with you" to Barbara, confront the issues of providing an associate pastor to fill Donna's void, the tasks of October grow as fast as the pumpkins in the fields! Generally, the Fair is enough to keep us all busy all month! This autumn season we must pull on our overalls, tie on aprons and rejoice in the many helping hands and open hearts in this church family to work together to bring in the harvest of God's blessings and of our year's endeavors. Amen.

Laurel Cole
Deb Copes
Julie Dostie
Tom Fulda

Judy Graham
Steph Heneghan
Bill Hoffman
Don Pagnucco

Candy Smith
Gail Tine
Val Triblets



A "Welcome Table" has been established in Chapin Hall by the Board of Deacons to provide information and conversation to any visitor or prospective new member. The table includes a WELCOME banner quilted by Deacon Stephanie Heneghan. Recently, a visitor commented that she felt a wonderful, positive spirit within our congregation. Please help us by warmly acknowledging visitors in the sanctuary and inviting newcomers downstairs to Chapin Hall.



WE NEED YOUR HELP!!

Thursday, October 28, 2010

In Chapin Hall

9:00 a.m. - 2:00 p.m.

Bring your peelers, rolling pins, energy and appetite (you get to sample a piece of pie when we are finished!) The more volunteers we get the sooner we get done. These pies will be served as dessert at the

Roast Beef Dinner on Saturday night, October 30 and some of them will be sold at the Country Fair during the day. Please come!! If interested in helping please speak to Marsha Hoffman, 860 563-1367 or Grace Cole, 860 529-4215 or just simply be there!



Board of Missions

Neighbors in Need

I want to share a letter with you that we recently received from one of our Covenant to Care families. This summer, we collected household items, furniture, cookware, etc. for a family that our social worker is helping, and Meghan Kelly and Jay Montana delivered those items with a truck over the summer. The letter goes like this:

“To the nice people who donated the furniture and other things to our family, we would like to say thank you so very much! Before your help our place was really bare and now with the beds, dishes, and couch it is no more – much more like a home! Thank you, thank you, thank you and thank you again! I’m very glad to know there are nice people willing to help our family in our time of need! Thank you one last time! With love, Mya, Mikie, Chammell and Charlene”

Your Board for Missions helps a lot of people with the money you donate to Benevolence, but seldom do we have the opportunity to see first-hand how much of an impact those donations of time, goods, and money have for our neighbors in need. Whether across the globe or right here in our own neck of the woods, the work we do as a church of mission is vital and desperately needed by so many, and the need we touch may never be known to us.

Across the globe, the country of Pakistan suffered a devastating flood this summer. One third of the country was under water. An estimated 1.5 million people have lost all they owned, are homeless, and many are finding it hard to find food for their families. Church World Service, through UCC’s Global Ministries, is already there, and helping however they can, including the distribution of emergency food packets and shelter kits. Mobile medical clinics are providing emergency health care. But they also need money to keep supplies coming in. The UCC has issued an appeal to help Pakistan. Your Board for Missions has responded by sending \$2000 from our Special Missions Fund to help in Pakistan. Please pray for our neighbors in Pakistan, their leaders, and all emergency response workers. Please also help the people of Pakistan by sending checks to RHCC made out to Wider Church Ministries UCC, marked for "Pakistan Flood Relief." We intend to match any contributions from the congregation up to \$1000.

100% of donations received by the UCC will be utilized for relief and recovery initiatives. Administrative costs are covered by generous donations to Our Church's Wider Mission (OCWM).

When Christ calls us to love our neighbors, he really doesn't say "love your next-door neighbors." He is speaking much more generally. Our neighbors, our brothers and sisters, are everywhere, both here and abroad. And our mission is simple. We help where the need is. And often the need is in both places. And our neighbors are many!

As always, there are many opportunities to help our neighbors this year through the Board for Missions. Please commit to helping out with these events:

Neighbors in Need Special Offering – Sunday, October 3

Neighbors in Need is the UCC's annual offering to support ministries of justice and compassion throughout the United States, including the Council for American Indian Ministries (CAIM), justice and advocacy efforts, and direct service projects funded by the UCC's Justice and Witness Ministries. Neighbors in Need helps make another world possible. It needs your support. Please give generously. See Marge Murk for more information, or visit <http://www.ucc.org/nin/>

Hands on Hartford Day of Service – Sunday, October 16

Thanks to everyone who has signed up so far for the Day of Service. We look forward to our very first church-wide, all-ages, day long missions event! Contact Thomas Kainamura for more information.

Fall Church Fair – Saturday, October 30

Missions is participating with a booth for kids, including grab bags, and a photo op!

Foodshare's Turkey and a Twenty – Sunday, November 21

Our goal this year is 100 turkeys and 100 donations (\$2000). Bring a frozen turkey and twenty dollars to RHCC anytime between 9:30 a.m. and 1:00 p.m. The turkey is to get a local family through the holidays, and the \$20 is to help Foodshare feed hungry families throughout the year! See Rich Pawlich-Pagliccio or Stephanie Kelly for more information. Or check www.foodshare.org, and look for our team "Rocky Hill Congregational Church, UCC."

Project Toy Drive – Sunday, December 12

To benefit the children of women who are incarcerated at Niantic Prison. Bring new, unwrapped toys to church, and the toys will be delivered that afternoon to the Hartford Seminary, and distributed to the kids before the Christmas holiday. See Michael Bower or Pastor Donna for more information.

Back Bay Mission Trip – September 4-11, 2011

Sign Me Up! We are beginning to plan the next trip to Biloxi! There will be more information coming soon. This is a wonderful opportunity to help our neighbors on the Gulf Coast and to be part of the amazing ministry of Back Bay Mission. See Michael Bower, Lynne Lataille, or Pastor Donna for more information. Or talk to someone who has gone before! Or check out <http://www.thebackbaymission.org/>

Where did your Benevolence Donations go this summer?

Our Church's Wider Mission (OCWM) - \$5000 Christian Activities Council - \$2000
Hands on Hartford - \$500 Operation Fuel - \$1500 Pakistan relief (from Special Missions Fund) - \$2000

Yours in Faith,

Michael H. Bower, Board for Missions, Chair

Your Board for Missions are: Michael H. Bower – Chair, Linda Calcagni, Bob Carberry, Dave Edwards, Tom Kainamura, Stephanie Kelley, Meghan Kelly, Marge Murk - Secretary, Rich Pawlich-Pagliccio

Let Us Know Your Favorite Hymns



Hymns are an essential part of the journey of faith and an essential element of worship life at RHCC, UCC. Each of us has our favorites - those words and tunes that invite us into God's presence and into the Christian story. Sunday, October 31 is the annual Hymn Festival Sunday, and worship will include singing of congregational favorite hymns, so let us know your favorites. Fill out this form, and drop it into the marked basket in the narthex or outside the office.

Name
My favorite hymns:
1.
2.
3.

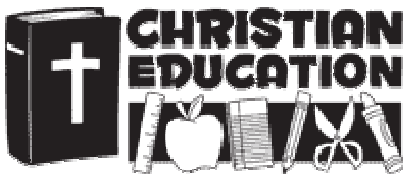

S.P.I.R.I.T. Corner Check-in

September was a busy month as we welcomed back our church school family with fun, food, and fellowship. We introduced our theme for the year, “The Body of the S.P.I.R.I.T” and are looking forward to learning, growing, and teaching together over this year. It will be a journey as we learn and discover who we are as the Body of Christ, but one that we hope the whole congregation will join us in. And, to make joining in easier, you can now find more information about what we’re learning in each Sunday’s Bulletin. Looking forward to another exciting month in October!

Safe Church Volunteers Needed!

Want to see what we’re learning in Church School, participate in discussion, crafts, and games, all while getting to know the children & youth of RHCC, UCC? Yes! Every church school classroom (including the youth room) and youth event needs at least two adults present to be in-line with the RHCC Safe Church policies. If you’re interested in being a safe church volunteer, even if it’s just one time, please email Meghan Young at christianedrhc@gmail.com or sign-up in Chapin Hall!

Here’s What’s Happening This Month:

Be sure to check the church website for details about events, as well as updates and changes to the calendars.

S.P.I.R.I.T Church School Calendar: *What we’re learning this month.*

Date	Scripture/Lesson
Sunday, October 3	World Communion Sunday: Communion Sunday, Family Worship
Sunday, October 10	Genesis 3 → “In the garden”
Sunday, October 17	Genesis 6:5-9:17 → “The flood”
Sunday, October 24	Genesis 11:1-9 → “The tower of Babel”
Sunday, October 31	Genesis 32:1-33:17 → “Jacob & Esau Reconcile”

Lunch Bunch Calendar: October – *Open to grades 6th-12th*

Date	Event
Sunday, October 3	Lunch Bunch Gear-Up → 11:30 AM-1PM
Friday, October 8	Youth Night In → 6 PM – 10 PM <i>Join us at the church for Dinner & a Movie</i>
Sunday, October 17	Lunch Bunch → 11:30 AM-1 PM
Friday, October 22	Youth Night Out → 6 PM – 10 PM <i>Can you find your way out of the moonlit corn maze?</i>

RHCC COUNTRY FAIR

Saturday, October 30th
9 a.m. - 2 p.m.

How can I help with the RHCC Country Fair this year?

The Fair Committee is so glad you asked!! We're very excited for the fair this year. We have some new booths and renewed energy and there are many opportunities for you to be a part of it.

1. The Apple Barrel – (Mary Dean 860-529-8424) – looking for donations of baked goods, homemade soup mixes, birdseed, peanut butter, cans of Crisco.
2. Silent Auction – (Deb Copes 860-257-1099) – looking for donations of Goods & Services to be sold at the auction, as well as baskets, packaging materials, ribbons and bows.
3. Jewelry – (Phyllis Wilkey 203-238-7876) – looking for children's, women and men's jewelry, as well as fashion scarves and pocketbooks.
4. The Toy Shop – (Candy Smith 860-563-4498) – looking for new or gently-used toys, board games, puzzles etc.
5. Arts & Antiques – (Hilaire Leavitt 860-529-3814 or email halx@rcn.com) – looking for art, china, crystal and collectibles. If you have small furniture to donate, please contact Hilaire before dropping it off. Do you have an item not suitable for bringing in? She can display pictures of it so that interested parties can contact you for sale details.
6. Indoor Tag Sale – (Trustees/Steve Ware 860-563-5631) looking for donations of dishes, glassware, house wares – **no** sporting equipment please. Volunteers are needed to help sort and price items the week before the fair.
7. Tool Booth – (Neal Cox 860-563-4143) – looking for donations of tools, electronic items and photographic equipment.
8. Holiday House – (Lynn McKenna 860-513-1025) looking for wooden sleds and women's/children's white ice skates.
9. The Roast Beef Dinner (Marsha Hoffman 860-563-1367) – looking for volunteers to help set up; servers for dinner and clean-up. She will also need volunteers for pie baking.

Our committee appreciates all the donations, time and talents you provide for the fair. We look forward to seeing you on the 30th!

Jim Stevens, Co-Chair
Phyllis Wilkey, Co-Chair
Bob Simmons
Elaine Somes
Lynn McKenna
Nancy Flynn, Treasurer
Marsha Hoffman, Consultant

Neal Cox
Annie Hokans-Doll
Candy Smith
Mary Dean
Don Pagnucco
Polly Pagnucco

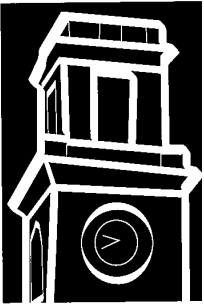

WORSHIP SCHEDULE

**Sunday Morning Worship
Communion 1st Sunday
10:00 a.m. with childcare**

2010

SUNDAY	MONDAY	TUESDAY	WEDNESDAY
3 NIN OFFERING Scrip Pickup 11:30am Lunch Bunch 1:30pm Pet Blessing	4 5:30pm Yoga with Lynn 7:00pm Women's AA 7:00pm RHCC Bowling 7:30pm Bell Choir	5 7:00pm Boards/ Committees	6 9:00am Quilters 12:00pm YOGA w/Lynn 12:30pm Bible Study 6:00pm Yoga with Pam 7:30pm Adult Choir
10 Barbara's Last Day 10:00am Baptism	11 5:30pm Yoga with Lynn 7:00pm RHCCNS Mtg 7:00pm Women's AA 7:00pm RHCC Bowling 7:30pm Bell Choir	12 8:30am Breakfast Club 7:00pm Council	13 9:00am Quilters 10:30am Book Study 12:00pm YOGA w/Lynn 12:30pm Bible Study 6:00pm Yoga with Pam 7:30pm Adult Choir
17 11:30am Sermon Talkback 11:30am Lunch Bunch 2:00pm RHCCNS Party	18 5:30pm Yoga with Lynn 7:00pm Women's AA 7:00pm RHCC Bowling 7:30pm Bell Choir	19	20 9:00am Quilters 12:00pm YOGA w/Lynn 12:30pm Bible Study 6:00pm Yoga with Pam 7:30pm Adult Choir
24 8:30am New Member Breakfast 2:00pm Installation Council 3:00pm Donna's Installation	25 5:30pm Yoga with Lynn 7:00pm Women's AA 7:00pm RHCC Bowling 7:30pm Bell Choir	26	27 12:30pm Bible Study 7:30pm Adult Choir
31 SCRIPT DEADLINE HYMN SING SUNDAY			

VOICE MAIL INSTRUCTIONS – If you call the church and the Voice Mail answers, you do not have to listen to the entire message. Anytime during the message you can have the call transferred directly to the person you are trying to reach by simply keying in the following numbers:

NOTE: After October 10 Donna will be at Ext 202

Barbara Libby, Interim Pastor	202	Meghan Young	204
Donna Manocchio, Senior Pastor Elect	203	Will Kanute, Dir. of Music	207
Carol Harvey, Office Secretary	201	Dick Webster, Sexton	205

ROCKY HILL CONGREGATIONAL CHURCH

805 Old Main Street – Rocky Hill, CT 06067

(860)529-4167 office • (860)257-9637 fax
 office @ rhccucc.org • website: rhccucc.org
 Office Hours 8 am – 2 pm – Monday – Friday

The Reverend Barbara J. Libby, Interim Pastor
The Reverend Donna K. Manocchio, Associate Pastor
The Reverend Arthur C. Weil, Minister Emeritus
Will Kanute, Director of Music

THURSDAY	FRIDAY	SATURDAY
	1	2 8:30am Yoga w/Lynn
7 8:30am Yoga with Lynn 5:30pm TOPS 7:00pm Fair Meeting 8:00pm Men's AA	8 6:00pm Youth Night	9 8:30am Yoga with Lynn 6:30pm Dinner & Movie
14 8:30am Yoga with Lynn 5:30pm TOPS 7:00pm Theology on Tap 8:00pm Men's AA	15	16 8:00am Hands on Hfd Day 8:30am Yoga with Lynn 10:45am Yoga with Lynn 7:30pm Coffee House Cabaret
21 8:30am Yoga with Lynn 5:30pm TOPS 7:00pm Women of the Bible 8:00pm Men's AA	22 UCC Annual Meeting 6:00pm Youth Night Out	23 UCC Annual Meeting 8:30am Yoga with Lynn
28 FAIR SETUP 9:00AM APPLE PIE WORKSHOP	29 FAIR SETUP	30 9:30am CHURCH FAIR 5:30pm ROAST BEEF DINNER



October 9
6:00pm
"Elizabethtown"

**“SCRIP-SURE”
Order Schedule**
Scrip deadline is
October 31 for
pickup on
November 7

HANDS ON HARTFORD

CAN YOU HELP? Part of the day of service will include packing of personal care items for the residents of Peter's Retreat and others who come in for services through Hands on Hartford sponsored organizations. We are asking church members to bring in some of the following items, and put them into the boxes located in the Narthex and Chapin Hall. Please contact Thomas Kainamura (thomas.kainamura@baml.com or 257-4203) if you have questions or would like to help out.

Toothpaste/ Toothbrush
 Fingernail Clipper
 Bar Soap

Deodorant
 Washcloth
 Comb/Brush

Hand Sanitizer
 Shampoo
 Body Lotion (for men)

THANKS for any help you can give! Call Tom at 860-922-6210 with questions.



- | | |
|------------------------|---------------------|
| 4 Charles Friday | 17 Lisa Gilbert |
| Stacy Veley | Christina Engel |
| Sandra Mason | Jillian Fulda |
| 5 Edward Day | Nate Robbins |
| 6 David Fandetti | 18 Mary Dean |
| 7 Irene Moore | 19 Will Kanute |
| Devin Gagnon | Christopher Young |
| Emily Doten | 21 Thomas Schreier |
| 8 Whitney Pirre | 22 Diana Gengenbach |
| 9 Elaine Vicino | Max Kainamura |
| Anne-Louise Griswold | 23 Albert Griswold |
| Judy Charamut | Joshua Bell |
| Rebecca-Lee Molina | 24 John Sword |
| 10 Joseph Malespini | Pat Howland |
| 11 Matthew Gagnon | 26 Elton Harvey III |
| Karen Jensen | Nancy Harlow |
| 12 Katie Hoffman-Fulda | Tim Bengston |
| Will Knight | Alicia Stewart |
| 13 Barbara Libby | 27 Kathleen Mosure |
| 14 Brian Wilcock | 28 Bob Hansen |
| 15 Peter Graham | Jean Goff |
| 16 Phylis Dexter | 29 Jan Pierson |
| Darrell Peterson | Donna Roberts |
| Lisa Benson | 30 James Pickett |
| 17 Cindy Tennyson | 31 Nancy Rolfe |
| John Molina | |

Martin and Jean Sudell
were married on
October 10, 1964

Tom and Doris Schreier
were married on
October 22, 1949

Don and Anita Watson
were married on
October 25, 1947

Nancy and Doug Robbins
were married on
October 20, 1956

Ralph and Priscilla Lexa
were married on
October 29, 1949



Blessing
of the Animals

**Sunday, October 3rd at
1:30 p.m.**

All pets are welcome (within
reason!)

Brief service on church grounds

Certificate to be presented to your animal

Snacks for animal (and human alike!)

Please call Joan Diaz (613-2889) if you wish to attend.

Francis of Assisi was known for his love of animals, and it has been a tradition in many Christian churches to offer a blessing to those pets who are our companions, comforters, and beloved family members. You are invited to bring your family pets to the side yard of the church to receive a blessing and to join in celebrating God's gift of animals in our lives. The blessing will begin at 1:30 p.m., giving you time to go home after worship, have a bite of lunch, and get back to church with your pet. There will be refreshments for our guests of honor afterward.



IF YOU LIKE TO BOWL – PLEASE JOIN US!

Our RHCC 2010-2011 Bowling Season begins in October 2010 and goes thru April 2011. We are looking for full time bowlers (every week), part-time bowlers (we will try to accommodate an every other week or part time schedule with another bowler for you), and we are looking for folks to be on our substitute bowler list. Please contact Joan and/or Jim Ross if you would like to join us in any of these capacities! We have a lot of fun and don't expect anyone to be too serious about their ability.

The league meets on Monday nights at Bowl-O-Rama on the Berlin Turnpike from October thru April. Bowling Starts at 7:00pm and costs \$12.00 a week which includes 3 strings of bowling and league dues. Joan and/or Jim can be contacted via e-mail at JJJROSS@GMAIL.COM or via phone at 860-563-5397 for more information or to sign up for the league now!



In July, Reverend Ed Ayala and I met with Doug Sudell, CEO and Doug's assistant, Tom Bright from Hands on Hartford. We discussed a few programs that we could corroborate to help the poor and needy in Hartford.

Adventures in the City

Once again Reverend Ayala, Shirley Thompson and their staff offered an outstanding educational experience for the youth of Hartford.

The regular program of elementary school age served 221 children.

Our regular sites were Milner School, Grace Lutheran Church and North United Methodist Church. The main subjects were Math, Science and Reading. Our off site attendance was 501. A new program was headed by our staff member Denise Best for Counselors in Training. This program targets 12-16 year olds to develop their leadership skills to help youth in our AIC program.

We also financially support a summer program led by Heads up Hartford. They served 87 children for a grand total of 823 youth.

I have a comprehensive report if anyone would like to review it with me.

I would like to thank the Board of Missions and our members for their continued support of the Adventures in the City Program and the Christian Activities Council.

Our Annual Awards Dinner is being held on Thursday, October 28, 2010. Tickets are \$50. We will be honoring Shirley Thompson, our Director of AIC. Jim Capraro, a leading expert on Comprehensive Community Development, is our main speaker. I urge our members to attend this very important awards program.

God Bless,

Rich Pawlich-Pagliccio

Delegate and Member Board of Directors

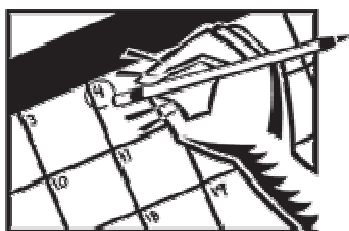

Due to a conflict with the date of Donna's Installation the program on Islam previously scheduled for October 24 will be rescheduled for November 21. Stay tuned for more information.

Musical Notes

Our new year is starting strong with the return of many members of the bell and senior choirs. There is always room for new faces and voices and we welcome anyone who likes to sing or ring to join us on Monday or Wednesday nights for rehearsals.

We have a busy year planned.

- In April the Senior Choir will travel to Charleston, SC where we have been invited to participate in the 3rd Annual Charleston Choir Festival. We will have the opportunity to join other choirs from around the country and the worlds under the direction of a guest conductor and “make a joyful noise”.
- Our Music series will be starting on Saturday, October 16th in Chapin Hall. We will be having a cabaret featuring the talents of Liz Reed-Swale. Tickets are on sale now for \$10/pp. They can be purchased through the website, by calling the office, after church on Sundays or at the door. Liz is a talented musician and member of our church. Proceeds from the cabaret will go towards defraying costs for the choir’s trip.
- We once again will be starting our search for Will’s replacement. In the coming months we look forward to hearing from you as we begin this task.



Lions Club Fundraiser

Many, many thanks to the church members, staff, friends and businesses that contributed to our success: Even losing one night to rain ...

We made a \$ 801.50 profit.

As you can see, it took a Village! YOU ALL ROCK!

Alyssa Somes
Big Y
Bob Inderbitzen
Carol Harvey
Cheryl Hummel
Cindy Hunt
Donna Manocchio
Hilaire Leavitt

Jan LaCava
Jim Day & boys
Jim Stevens
Judy Graham
Lynn & Dick Webster
Mary Lynn Sacerdote
Tom Sacerdote

Nancy Harlow
Pat and Mark Walworth
Phyllis and Robert Wilkey
Polly and Don Pagnucco
Sue Monaghan
Val Triblets
Westside Market

“THE BREAKFAST CLUB”
Tuesdays at 8:30 AM
October 12, November 9 and December 7
TIM HORTON’S
Silas Deane Highway, Rocky Hill

Come join the club! Meet with others for coffee and conversation (or a full breakfast of you 'd like!) and discussion about life, current events, church, and the way of faith. Bring your thoughts, questions – and a friend or two. Call the office, or email Donna (associate@rhccucc.org), or arrive at Tim Horton's!

Women of the Bible Scripture Study
(formerly “Bad Girls of the Bible”)
Once-a-month Thursdays, 7:00 PM in the Fiorilli Room

Join with other women to explore the stories of women in our Scriptures. As we seek to understand the meaning of God's word and work in our lives and in our world. Come and pray, read, talk, laugh, and eat together!

We begin this September with an exploration of the women in Jesus' genealogy as listed in the gospel of Matthew: Bathsheba, Rahab, Ruth, and Tamar. The selected passages are available at church two Sundays prior to meeting.

Thursday, October 21	Rahab
Thursday, November 18	Ruth
Thursday, January 20	Tamar

Theology on Tap
Thursdays at 7:00 PM
October 14
November 11, December 9
Wood-N-Tap
12 Townline Road, Rocky Hill

Are you interested in sharing questions and experiences about God and God's presence in your life? If so, come and join with other church members and friends in the "back room" of the Wood-N-Tap restaurant. We discuss a different topic each month, so join us whenever you can. Bring a friend and see you at the Tap!

Contact Donna (associate@rhccucc.org or on FACEBOOK) if you have questions, want to suggest a topic, or can join us for a gathering.



Please join us on October 9, 2010 for a Pot Luck Dinner and a Movie at 6:00pm. Please note the new earlier time! The film will be *Elizabethtown*.

From Oscar winner, Cameron Crowe comes a potent blend of rock 'n' roll and classic comedy. Drew Baylor (Orlando Bloom) is a hot-shot designer whose life becomes completely unraveled when he loses his father and his job one fateful day. En route to Elizabethtown to visit his family, Drew meets Claire (Kirsten Dunst). She's beautiful, unstoppably positive, and just the girl to guide Drew on his journey back home and to teach him what it means to live and love along the way. Set against the backdrop of an incredible soundtrack, *Elizabethtown* is an amazing trip of love, loss and laughter.

Silver Lake Fall Celebration

- What: Silver Lake is celebrating and You are invited!
- When: Sunday, October 3rd from 3-5pm
- Where: At Silver Lake Conference Center
- Why: To celebrate and dedicate three finished projects; The Circle Cabins Commons Building, the new Amphitheater and the new Basketball Court.
- How: Gather at 3pm for hot cider and doughnuts (or lemonade and cookies if it is hot out!) Dedicate the building and amphitheater and end up at the Basketball Court for a game of "Mudge Madness."
- RSVP: jennm@ctucc.org or call 860 364-5526 x10 and give the number of folks coming.

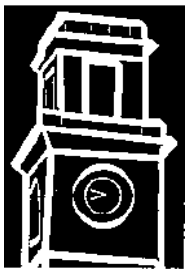

TOWER LIGHTING

Light the Tower! This is a special way to honor or memorialize your loved ones. The tower lights are on overnight and add to the electric bill. Your contribution of \$10 helps defray the cost. The names of your loved ones will be noted in the bulletin. While Chapin Hall renovations are being done the sign up list will be posted in the Fiorilli

Room or you can email me at office@rhccucc.org or call the church office at 529-4167 and I will write it on the signup sheet.

Rocky Hill



Military Whist

Date: Thursday, October 7, 2010

Place: St. James Assembly Hall
767 Elm St. Rocky Hill

Time: 6:00-9:30pm

Door prizes, refreshments and raffle

To benefit the VCT Program

For information and tickets, please call

Doug Robbins, Program Director of Volunteer Care Teams, at 860 258-2799 x144

How about a little equal-exchange for some bunny special?

“Around the world coffee and fellowship come together where we share community. A warm pot of coffee is often the centerpiece of fellowship hour and other gatherings.”



Equal Exchange Coffee, Tea or Hot Cocoa would make an excellent gift! Why not pick some up after church this Sunday?

During fellowship time in Chapin Hall, the Inreach Committee has available for purchase: Gourmet Coffee at \$6.25, Tea at \$3, Hot Cocoa Mix at \$5

For more information about the UCC Coffee Project: www.ucc.org/justice/coffee-project



Always Welcome! – Hunger never takes a holiday... Food Pantries need our help to meet the food demands...Please consider bringing a non-perishable food item, laundry detergent, or baby items to worship every time you come.

The large basket in the front foyer of the church welcomes all food donations. Pew Crew members have been taking your donations to the food pantry. Mark Williams sends a thank you note every month in gratitude for your generosity.

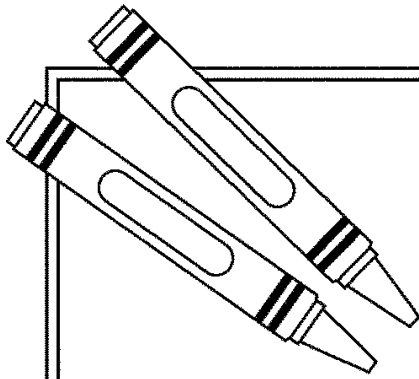

Just for **KIDS**

"And God said, 'Let the earth bring forth living creatures according to their kinds' And God saw it was good."

-Genesis 1:24-25

Unscramble these words to find names of animals that are found in the Bible.

ntalepoe _____ Deuteronomy 14:5

cooircdle _____ Leviticus 11:30

prdleoa _____ Revelation 13:2

hpsee _____ Deuteronomy 14:5

zlrda _____ Leviticus 11:29

ttcael _____ Genesis 1:25

uomse _____ Leviticus 11:29

mealc _____ Genesis 12:16

oatg _____ Deuteronomy 14:5

rhsoe _____ 1 Kings 10:25

earb _____ Revelation 13:2

niol _____ 1 Samuel 17:34

abt _____ Deuteronomy 14:18

eap _____ 1 Kings 10:22

odg _____ Exodus 22:31

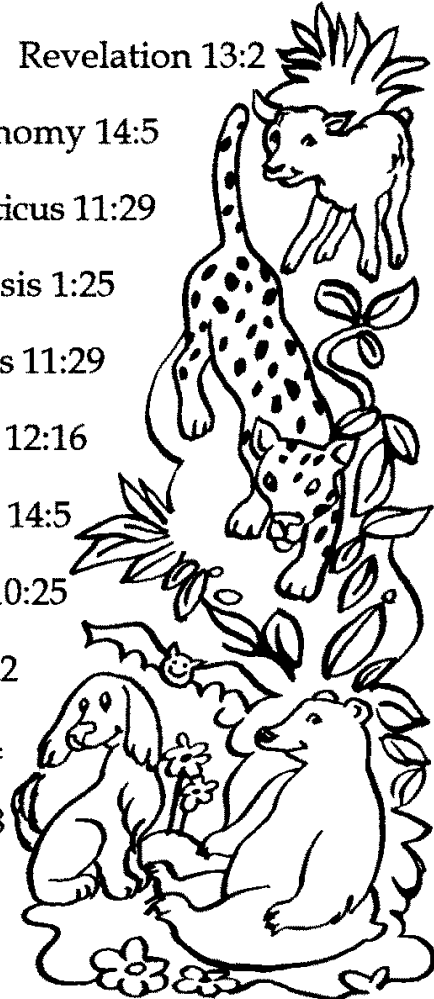

Bible Verses for Your Excuses

<i>You Say</i>	<i>God Says</i>	<i>Bible Verse</i>
“It’s impossible”	“All things are possible”	Luke 18:27
“I’m too tired”	“I will give you rest”	Matthew 11:28-30
“Nobody really loves me”	“I love you”	John 3:16, 34
“I can’t go on”	“My grace is sufficient”	Psalms 91:15
“I can’t figure things out”	“I will direct your steps”	Proverbs 3:5-6
“I can’t do it”	“You can do all things”	Phillipians 4:13
“I’m not able”	“I am able”	II Corinthians 9:8
“It’s not worth it”	“It will be worth it”	Romans 8:28
“I can’t forgive myself”	“I forgive you”	I John 1:9, Romans 8:1
“I can’t manage”	“I will supply all your needs”	Philippians 4:19
“I’m afraid	“I have not given you a spirit of fear”	II Timothy 1:7
“I’m always worried and frustrated”	“Cast all your cares on Me”	I Peter 5:7
“I’m not smart enough”	“I give you wisdom”	I Corinthians 1:30
“I feel alone”	“I will never leave you or forsake you”	Hebrews 13:5

--submitted by Jean Palmer

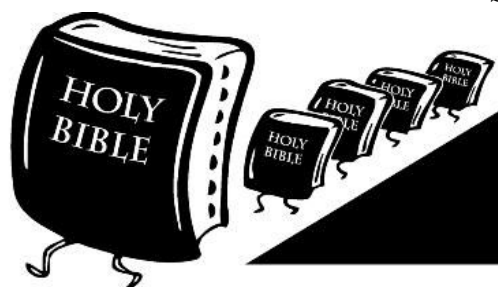



COMMUNITY EVENTS

The Connecticut Network to Abolish the Death Penalty and St. James Catholic Church would like to invite your congregation to a panel discussion entitled “**Faith, Experience, and Common Sense: Perspectives on the Death Penalty.**” This event will be on Monday, October 4 at 7pm at St James Catholic Church, 767 Elm St. Rocky Hill. Refreshments provided. Vicki Schieber, the mother of a murder victim, will be on the panel to share her experience, along with Deacon Pallotti at St. James Catholic Church and Ben Jones, Executive Director of the Connecticut Network to Abolish the Death Penalty. Contact Bo Chamberlin with ?s at bo@cnadp.org or call 614-581-5109

“Rocky Hill Food Pantry Cupboard Is Bare!! Come to a Benefit Car Show on Sunday, October 10th (raindate October 17th) at 11am – 3pm at Michel Angelo’s Plaza, 825 Cromwell Ave (Rt. 3) in Rocky Hill. 100% of all donations go to the Food Pantry.

Celebrate Recovery – Thursday nights at First Church in Wethersfield. The purpose of this ministry is to fellowship and celebrate God’s healing power in our lives through the 8 Recovery Principles. This experience allows us to be changed. By working and applying these Biblical principles, we begin to grow spiritually. 6:00-6:45 Dinner (\$4.00 donation), 7:00-8:00 Large group meeting, 8:00-9:00 Safe, supportive gender-specific small groups, 9:00-9:30 Coffee and Dessert / Crosstalk Café. For more information call 860 529-1575 x210 or email care@firstchurch.org



Yoga classes offered in Chapin Hall

Yoga with Pam – Quiet the mind, increase flexibility, reduce stress and promote health and wellness. Wednesday evenings at 6:00-7:30pm with Pamela Clark, R.N. Beginner and advanced beginner students welcome! Gift certificates available.

Yoga Offered by Core Power, LLC – Experience the dynamic flow and challenge of yoga which builds strength, balance and flexibility for an overall fit and healthy body. Classes are for all-levels with options for everyone! This class meets: Monday evenings from 5:30-6:30pm, Wednesday lunchtime from 12:00-12:45pm, Thursday mornings from 8:30-9:30am and Saturday mornings in from 8:30-9:30am. Contact Lynn MacDonald 860-550-4660 to register – Water bottle, yoga mat, and a friend!!

ROCKY HILL CONGREGATIONAL CHURCH
805 Old Main Street, Rocky Hill CT 06067
Telephone # 860 529-4167

Non-Profit Organization
U.S. POSTAGE PAID
Rocky Hill, CT

ADDRESS SERVICE REQUESTED
TIME VALUE MAIL

Permit #7

Mailed September 24, 2010

Jesus didn't turn people away. Neither do we.
The United Church of Christ:
No matter who you are,
Or where you are on life's journey...
You're welcome here.

COUNTRY FAIR



Rocky Hill Congregational Church
805 Old Main St., Rocky Hill
October 30th at 9:00 a.m. – 2 p.m.

- Indoor Tag Sale
- Apple Barrel
- Silent Auction
- Holiday House
- Tools
- Tea Room
- Jewelry
- Arts & Antiques
- Toy Shop
- Peace & Love Diner
- Quilt Raffle
- Missions Booth

Roast Beef Dinner

5:30 p.m.

Tickets \$10 adults / \$ 5 children

Children under 4 yrs old free (reservations required)

Call Church Office at (860) 529-4167